

DESCRIPTION

- ELECTRONIC BALLAST
- ELECTRONIC TRANSFORMER
- SWITCH MODE POWER SUPPLY

FEATURES:

- LOW THERMAL RESISTANCE
- HIGH INPUT RESISTANCE
- FAST SWITCHING
- ROHS COMPLIANT

MAXIMUM RATINGS (T_c=25°C)

PARAMETER	SYMBOL	VALUE	UNIT
Drain-source Voltage	VDS	60	V
gate-source Voltage	VGS	±20	V
Continuous Drain Current	ID	120	A
Drain Current-Pulsed	IDM	400	A
Total Dissipation	PD	100	W
Junction Temperature	T _j	150	°C
Storage Temperature Range	T _{stg}	-55-150	°C
Single Pulse Avalanche Energy (L=0.3mH)	EAS	285	mJ

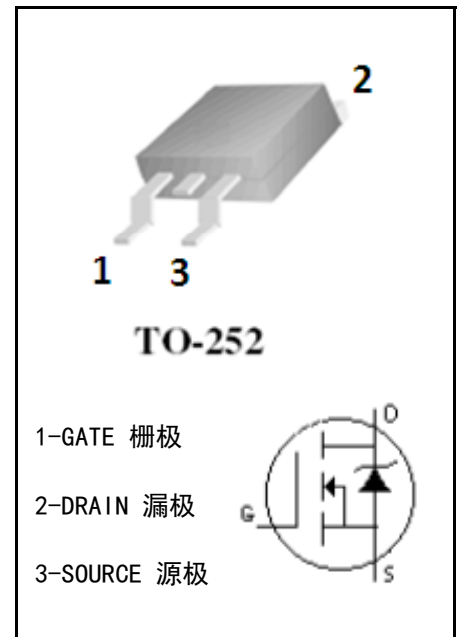
MECHANICAL

ELECTRONIC CHARACTERISTICS (T_c=25°C)

CHARACTERISTICS	SYMBOL	TEST CONDITION	MIN	MAX	UNIT
Drain-source Breakdown Voltage	BVDSS	VGS=0V, ID=250 μA	60		V
Gate Threshold Voltage	VGS (TH)	VGS=VDS, ID=250 μA	1	2.4	V
Drain-source Leakage Current	IDSS	VDS=60V, VGS=0V		1	uA
Drain-Source Diode Forward Voltage	VSD	VGS=0V, IS=10A		1.2	V
Gate-body Leakage Current (VDS = 0)	IGSS	VGS=±20V		±100	nA
Static Drain-source On Resistance	RDS (ON)	VGS=4.5V ID=20A		5.3	mΩ
		VGS=10V ID=20A		4.3	mΩ
Thermal Resistance Junction-case	RthJ-c			1.75	°C/W

■ DYNAMIC CHARACTERISTICS (T_c=25°C)

CHARACTERISTICS	SYMBOL	TEST CONDITION	MIN	TYP	MAX	UNIT
Input Capacitance	C _{iss}	V _{DS} =35V, V _{GS} =0V, f=1.0MHz	-	3250	4200	pF
output Capacitance	C _{oss}		-	1200	-	pF
Reverse Transfer Capacitance	C _{rss}		-	45	-	pF
Gate resistance	R _G	V _{gsDCBias} =0V, Speed=MED	-	1.5	-	Ω

■ SWITCHING CHARACTERISTICS (T_c=25°C)

CHARACTERISTICS	SYMBOL	TEST CONDITION	MIN	TYP	MAX	UNIT
Turn-On Delay Time	t _{d(on)}	V _{DD} =30V, I _D =20A, V _{GS} =10V, R _G =10Ω	-	12	-	ns
Turn-On Rise Time	t _r		-	10	-	ns
Turn-Off Delay Time	t _{d(off)}		-	55	-	ns
Turn-Off Rise Time	t _f		-	15	-	ns
Total Gate Charge	Q _g (4.5V)	V _{DS} =30V, I _D =20A, V _{GS} =10V	-	24	-	nC
Total Gate Charge	Q _g		-	49	-	nC
Gate-Source Charge	Q _{gs}		-	8	-	nC
Gate-Drain Charge	Q _{gd}		-	9	-	nC

■ DRAIN-SOURCE DIODE MAXIMUM RATINGS AND CHARACTERISTICS (T_c=25°C)

CHARACTERISTICS	SYMBOL	TEST CONDITION	MIN	TYP	MAX	UNIT
Diode Forward Voltage	V _{SD}	V _{GS} =0V, I _S =10A	-	-	1.2	V
Reverse Recovery Time	t _{rr}	V _R =30V, I _F =20A, di/dt=300A/μs	-	50	-	ns
Reverse Recovery Charge	Q _{rr}		-	120	-	nC

CHARACTERISTICS CURVE

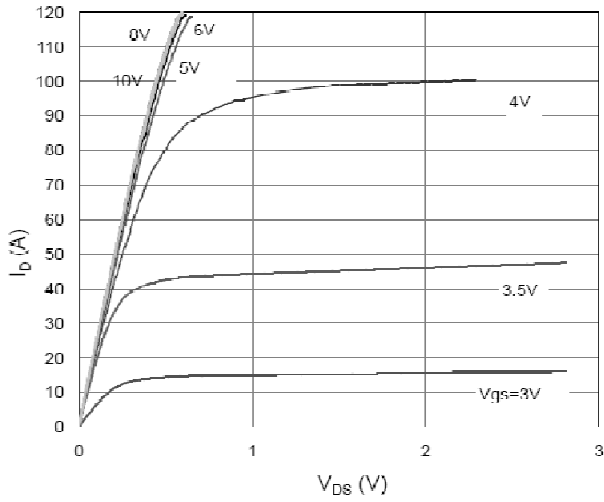

Output Characteristics

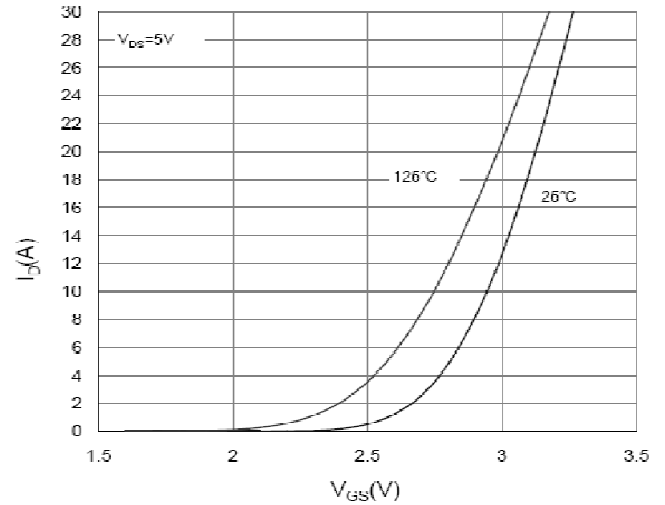

Transfer Characteristics

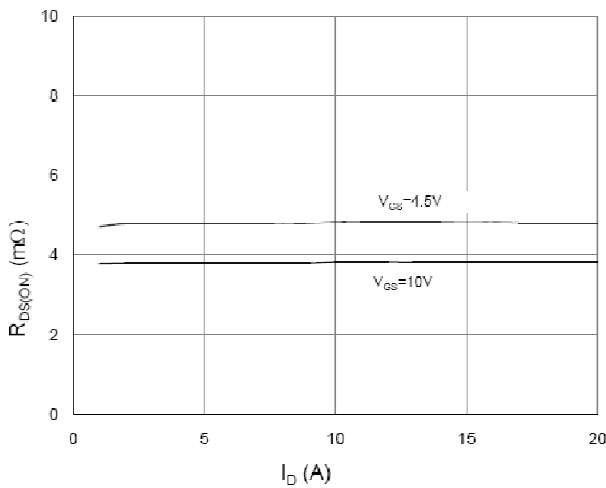

On Resistance Vs Drain Current

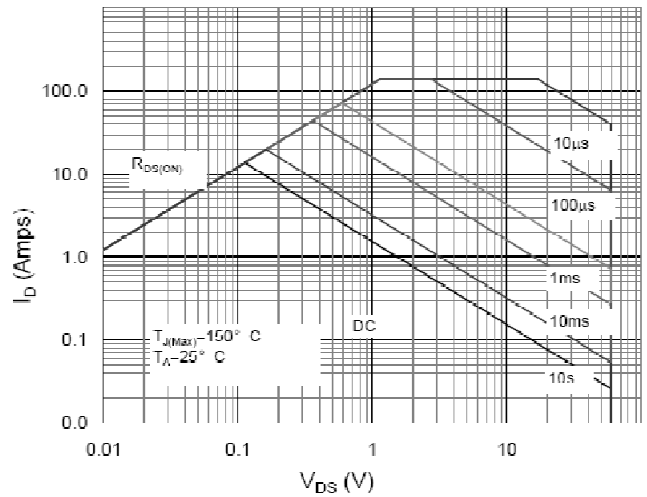

Maximum Safe Operating Area

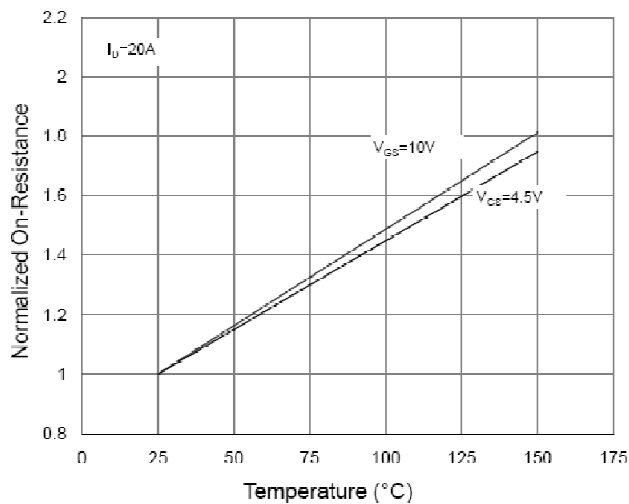

Rdson-Junction Temperature

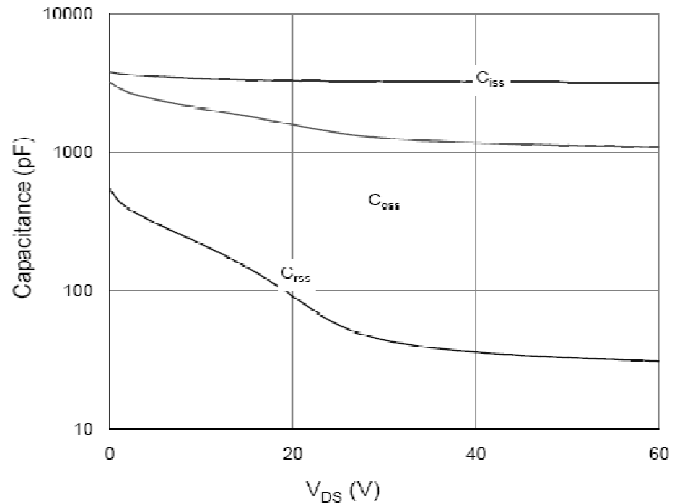

Capacitance



CHARACTERISTICS CURVE

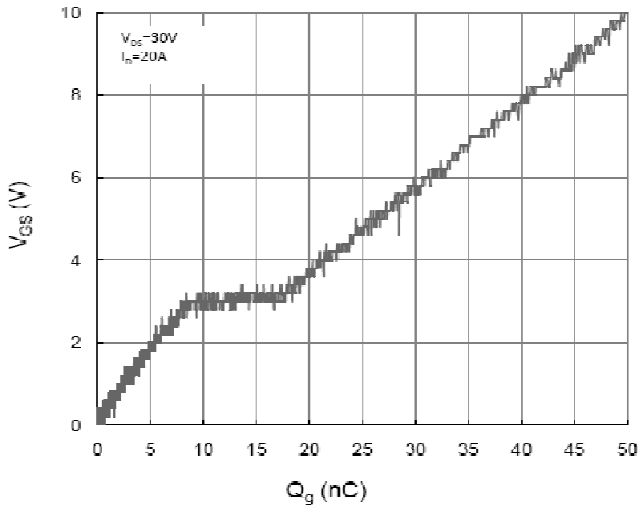

Gate Charge Waveform

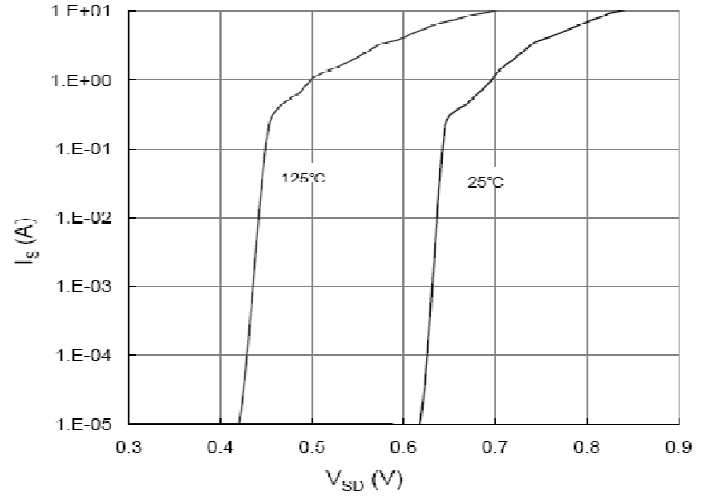

Source-Drain Diode Forward Voltage

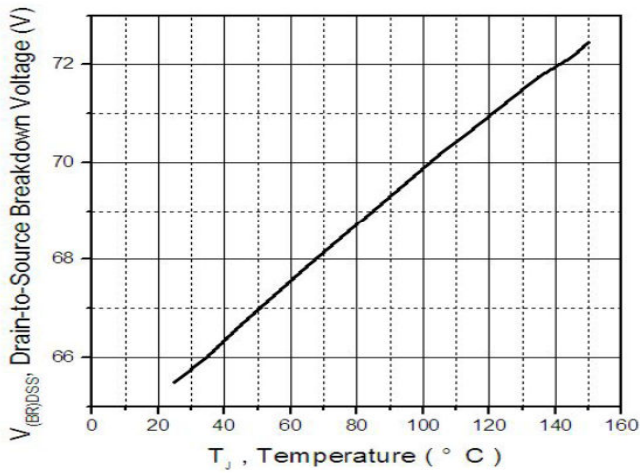

Breakdown Voltage Vs Junction Temperature

TO-252 MECHANICAL DATA
UNIT: mm

SYMBOL	MIN	NOM	MAX	SYMBOL	MIN	NOM	MAX
A	2.10		2.50	E	5.80		6.30
B	0.80		1.25	e1	2.25	2.30	2.35
b	0.50		0.85	e2	4.45		4.75
b1	0.50		0.90	L1	9.50		10.20
b2	0.45		0.60	L2	0.90		1.45
C	0.45		0.60	L3	0.60		1.10
D	6.35		6.75	K	-0.1		0.10
D1	5.10		5.50				

